

VIEW "A"
(SCALE : 4/1)

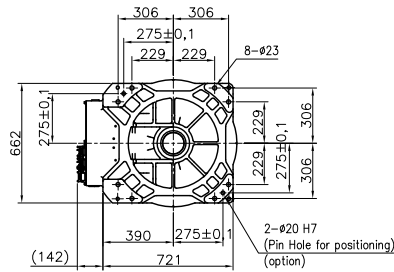

VIEW "B"
(SCALE : 1/1)

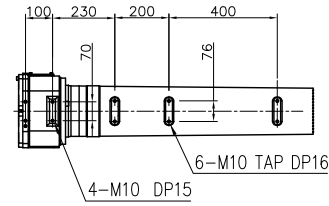

VIEW "E"
(SCALE : 1/1)

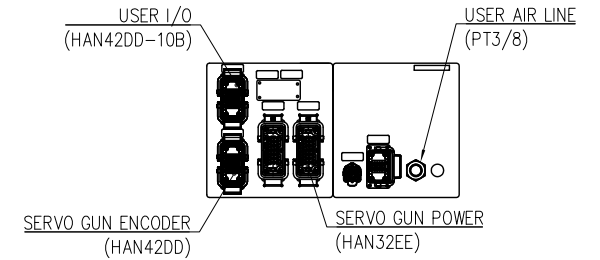
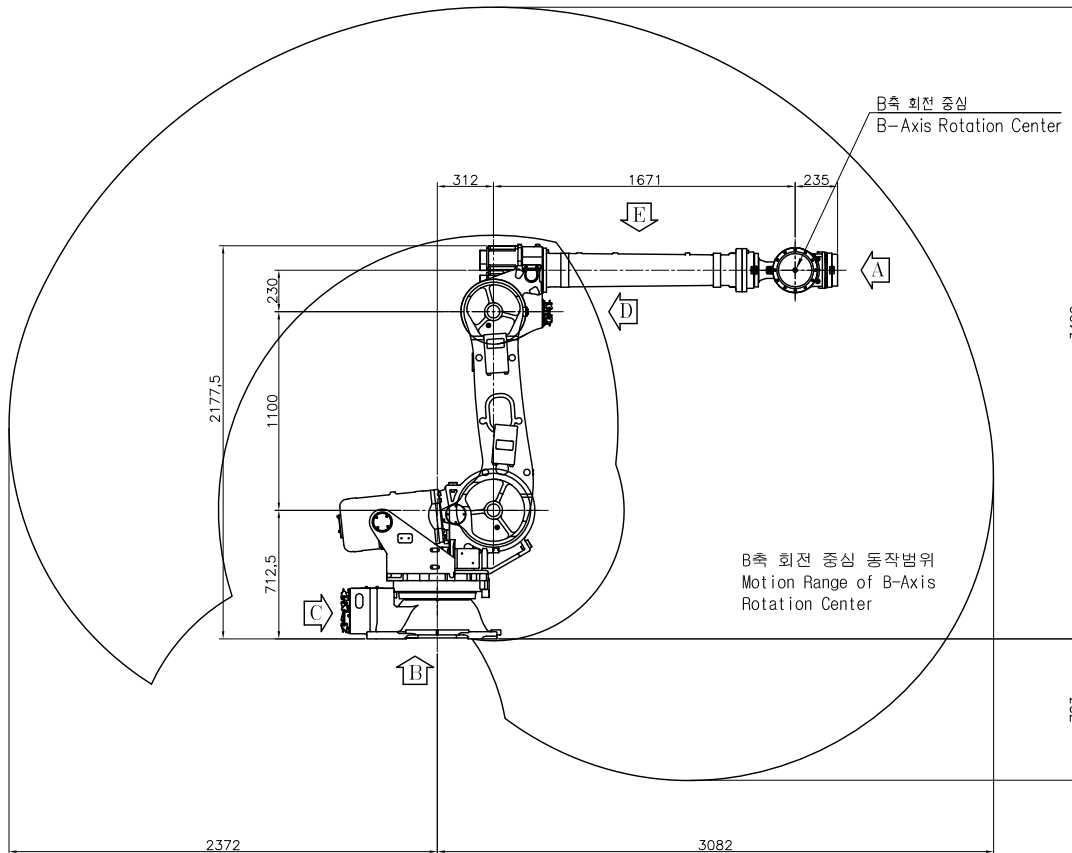
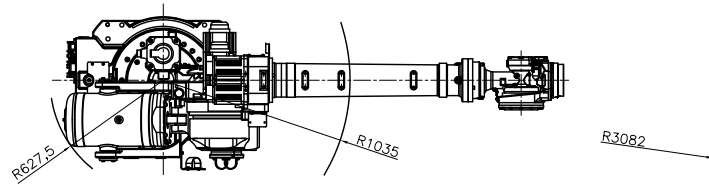

VIEW "C" <For Hi5a Controller>
(SCALE : 1/1)

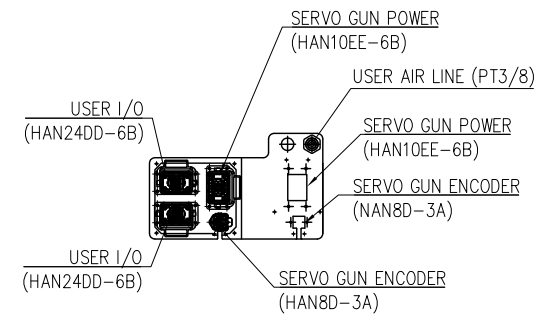
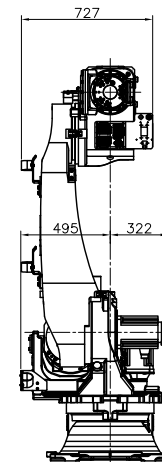

VIEW "D"
(SCALE : 1/1)

MODEL	HH130L	issue.1
DATE	2015.02.04	
HYUNDAI HEAVY INDUSTRIES CO.,LTD. ENGINE & MACHINERY DIVISION		

TECHNICAL SPECIFICATION SUBJECT TO
CHANGE WITHOUT NOTICE