

VIEW "A"  
(SCALE : 4/1)

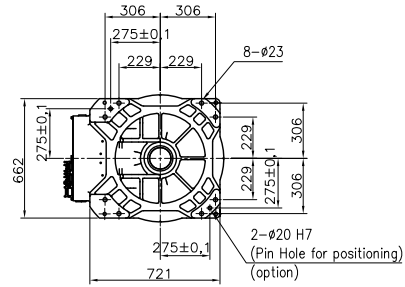

VIEW "B"  
(SCALE : 1/1)

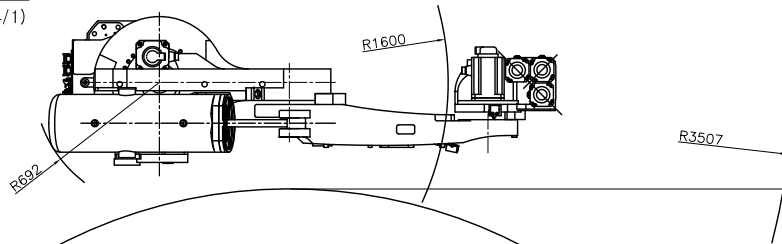
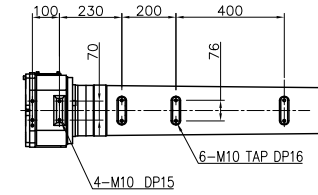

VIEW "E"  
(SCALE : 1/1)

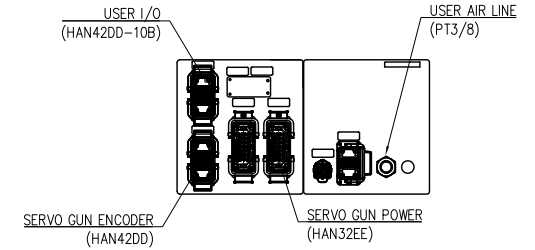
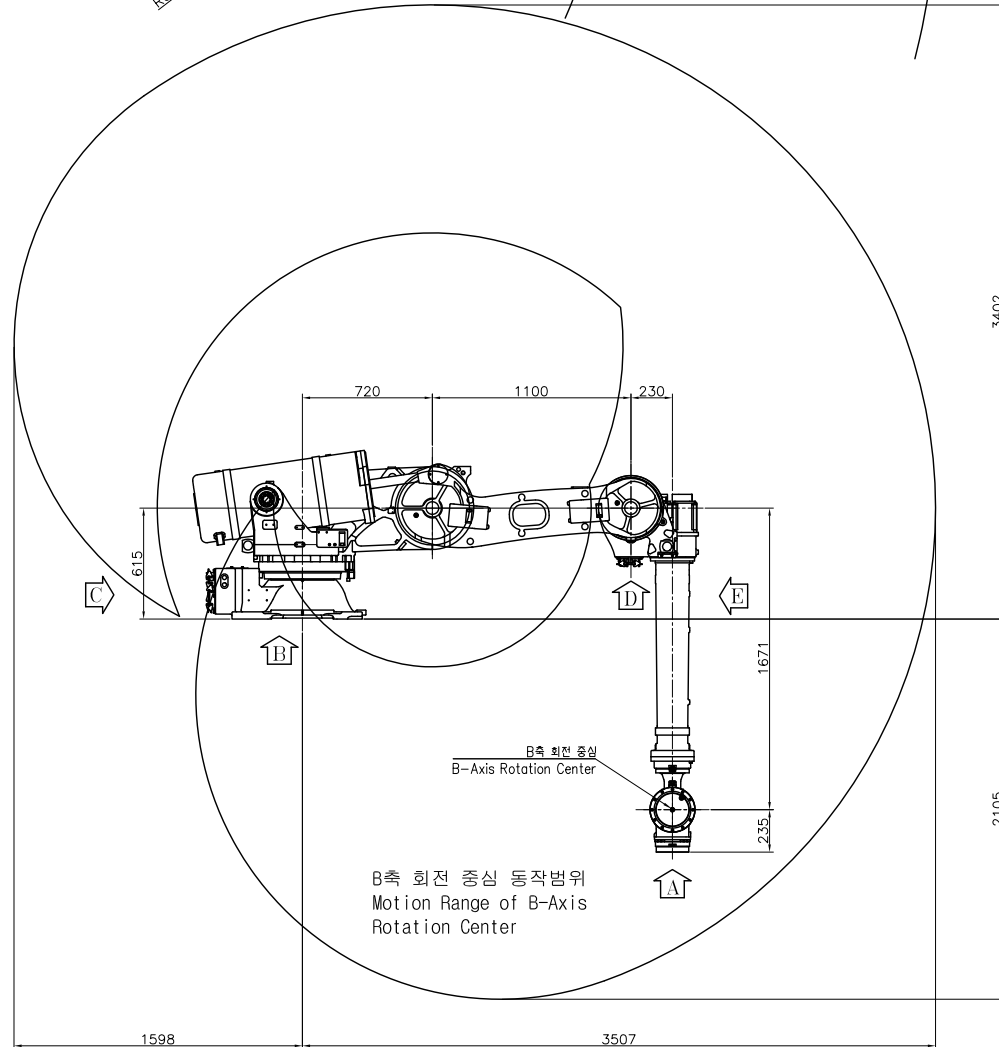

VIEW "C" <For Hi5a Controller>  
(SCALE : 1/1)

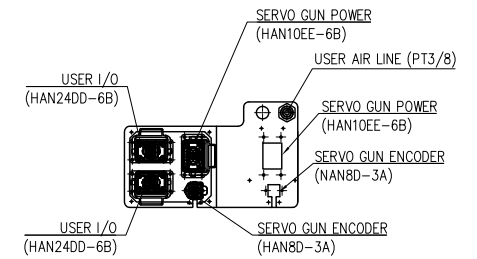
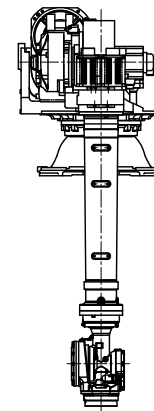

VIEW "D"  
(SCALE : 1/1)

TECHNICAL SPECIFICATION SUBJECT TO CHANGE WITHOUT NOTICE

MODEL	HH100SL	issue.1
DATE	2015.02.04	
HYUNDAI HEAVY INDUSTRIES CO.,LTD. ENGINE & MACHINERY DIVISION		