

VIEW "A"  
(SCALE : 4/1)

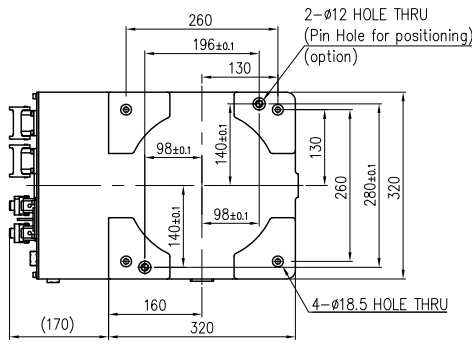

VIEW "B"  
(SCALE : 2/1)

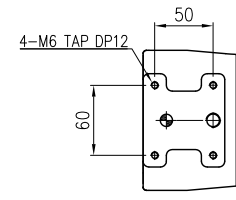

VIEW "E"  
(SCALE : 4/1)

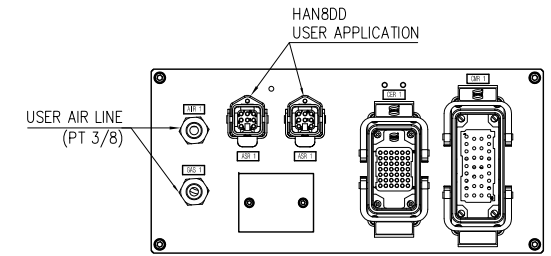
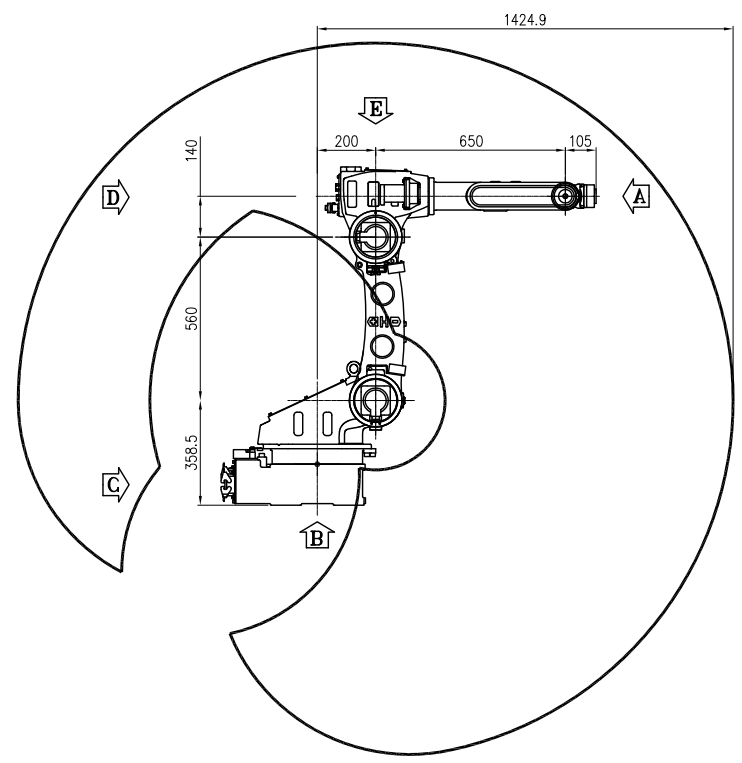
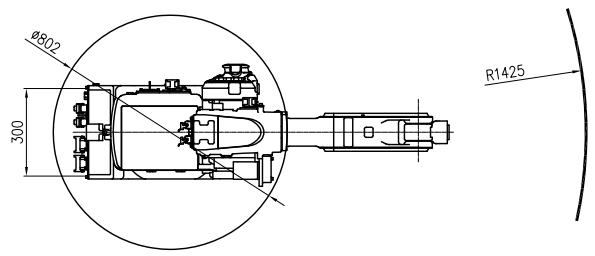

VIEW "C"  
(SCALE : 4/1)

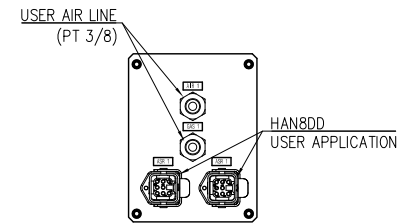
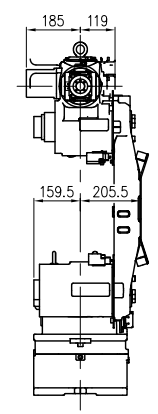

VIEW "D"  
(SCALE : 4/1)

TECHNICAL SPECIFICATION SUBJECT TO  
CHANGE WITHOUT NOTICE

MODEL	HA006A	issue.2
DATE	2015.03.12	
HYUNDAI HEAVY INDUSTRIES CO.,LTD. ENGINE & MACHINERY DIVISION		